

Sockets - Product Coding System

**Socket Product Group****Terminal Compliance**

- 1 : 6,3 mm x 5 Terminals
- 2 : 6,3 mm x 2 Terminals + 9,5 x 3 Terminals
- 3 : 6,3 mm x 2 Terminals + 4,8 x 3 Terminals

Cable Connection Positions No*

- 00 : w/o Cable
- 20 : 2 Cables
- 21 : 2 Cables
- 30 : 3 Cables
- 31 : 3 Cables
- 40 : 4 Cables
- 41 : 4 Cables
- 42 : 4 Cables
- 50 : 5 Cables
- 51 : 5 Cables

Cable Length

- 0 : w/o Cable
- 1 : 10 cm
- 2 : 20 cm
- 3 : 30 cm
- 4 : 40 cm
- 5 : 50 cm
- 6 : 60 cm
- 7 : 70 cm
- 8 : 80 cm
- 9 : 90 cm

Cable Cross Section of Cable(s) Carrying Highest Current**

- 0 : w/o Cable
- 1 : 0,50 mm²
- 2 : 0,75 mm²
- 3 : 1,00 mm²
- 4 : 1,25 mm²
- 5 : 1,50 mm²
- 6 : 1,75 mm²
- 7 : 2,00 mm²
- 8 : 2,25 mm²
- 9 : 2,50 mm²

Color / Packaging

- 1 : Black / Single
- 2 : Blue / Single
- 3 : Black & Blue / Pack of 2

* Cable connection positions are explained on the next page.

** Cable cross section information indicates the cross section of the cable(s) carrying the highest current of the product. Please refer to technical details on the next pages for all cable cross section information.

How Do I Choose the Cable Connection Position?

Compare the terminal layout of the product with the drawings below and use the connection number of the drawing accordingly.

Cable Connection Positions

Cable Connection Positions for Products with 2 Terminals

Connection Position No: 20

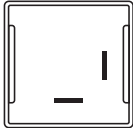

Connection Position No: 21

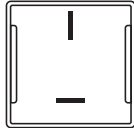

Cable Connection Positions for Products with 3 Terminals

Connection Position No: 30

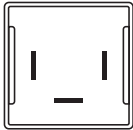

Connection Position No: 31

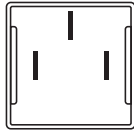

Cable Connection Positions for Products with 4 Terminals

Cable Position No: 40

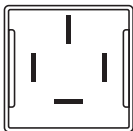

Cable Position No: 41

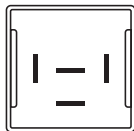

Cable Position No: 42



Cable Position No: 43

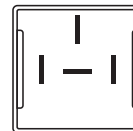

Cable Connection Positions for Products with 5 Terminals

Cable Position No: 50

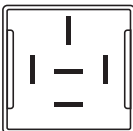



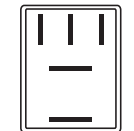





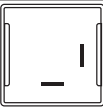

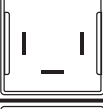
Cable Position No: 51

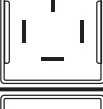
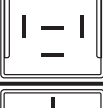

Sockets - With and Without Cable



Used in Product Series	Terminal Compatibility	Cable Yes/No	Color / Packing	Product Code	Cable Connection Position	Technical Drawing Number
700 & 710 & 203	5 x 6,3mm	No	Black / Single Blue / Single Black & Blue / Pack of 2	207.100.001 207.100.002 207.100.003	No Cable	1
720 & 730	2 x 6,3 mm 3 x 9,5 mm	No	Black / Single	207.200.001	No Cable	2
780	2 x 6,3 mm 3 x 4,8 mm	No	Black / Single	207.300.001	No Cable	3
700 & 710 & 203	5 x 6,3mm	2 Cables	Black / Single Blue / Single Black & Blue / Pack of 2	207.120.251 207.120.252 207.120.253		1
700 & 710 & 203	5 x 6,3mm	2 Cables	Black / Single Blue / Single Black & Blue / Pack of 2	207.121.251 207.121.252 207.121.253		1
700 & 710 & 203	5 x 6,3mm	3 Cables	Black / Single Blue / Single Black & Blue / Pack of 2	207.130.251 207.130.252 207.130.253		1
700 & 710 & 203	5 x 6,3mm	3 Cables	Black / Single Blue / Single Black & Blue / Pack of 2	207.131.251 207.131.252 207.131.253		1
700 & 710 & 203	5 x 6,3mm	4 Cables	Black / Single Blue / Single Black & Blue / Pack of 2	207.140.251 207.140.252 207.140.253		1
700 & 710 & 203	5 x 6,3mm	4 Cables	Black / Single Blue / Single Black & Blue / Pack of 2	207.141.251 207.141.252 207.141.253		1
700 & 710 & 203	5 x 6,3mm	4 Cables	Black / Single Blue / Single Black & Blue / Pack of 2	207.143.251 207.143.252 207.143.253		1
780	2 x 6,3 mm 3 x 4,8 mm	4 Cables	Black / Single	207.342.251		3
700 & 710 & 203	5 x 6,3 mm	5 Cables	Black / Single Blue / Single Black & Blue / Pack of 2	207.150.251 207.150.252 207.150.253		1
780	2 x 6,3 mm 3 x 4,8 mm	5 Cables	Black / Single	207.351.251		3
720 & 730	2 x 6,3 mm 3 x 9,5 mm	4 Cables	Black / Single	207.240.251		2
720 & 730	2 x 6,3 mm 3 x 9,5 mm	5 Cables	Black / Single	207.250.251		2

Sockets - With and Without Cable

Technical Drawing 1

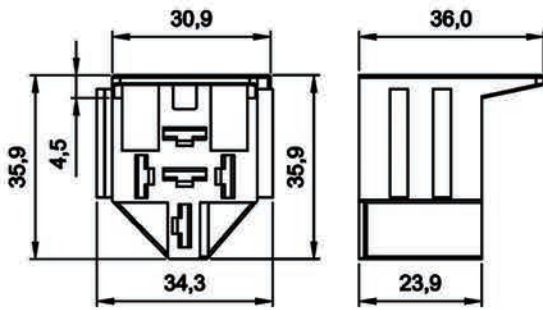

Technical Data

Terminals / Number of Terminals	6,3 x 0,8 mm / 5 Terminals
Material	PA66 GF30
Color	Black or Blue
Packing	Single or Pack of 2
Cable Alternatives	Without Cable, 2, 3, 4 or 5 Cables
Cable Cross Section	85, 86 : 0,75 mm ² 30, 87, 87a : 1,50 mm ²
Ambient Temperature	-40 / +80 °C

Technical Drawing 2

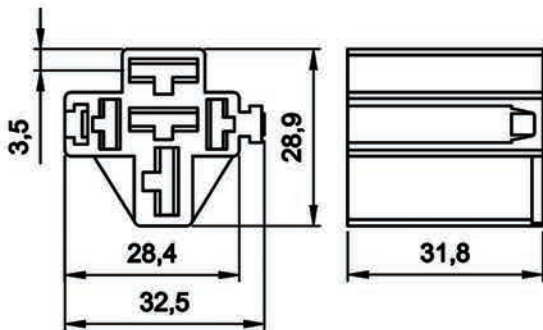

Technical Data

Terminals / Number of Terminals	6,3 x 0,8 mm / 2 Terminals 9,5 x 1,2 mm / 3 Terminals
Material	PA66 GF30
Color	Black
Packing	Single
Cable Alternatives	Without Cable, 4 or 5 Cables
Cable Cross Section	85, 86 : 0,75 mm ² 30, 87, 87a : 2,50 mm ²
Ambient Temperature	-40 / +80 °C

Technical Drawing 3

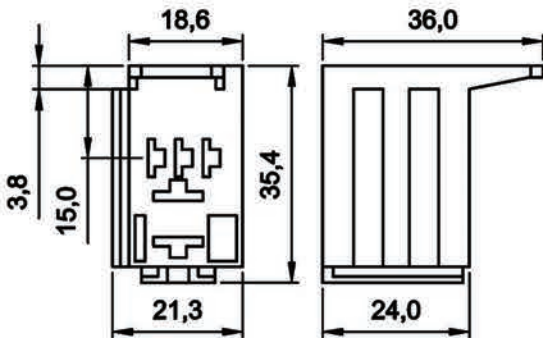

Technical Data

Terminals / Number of Terminals	6,3 x 0,8 mm / 2 Terminals 4,8 x 0,8 mm / 3 Terminals
Material	PA66 GF30
Color	Black
Packing	Single
Cable Alternatives	Without Cable, 4 or 5 Cables
Cable Cross Section	85, 86 : 0,75 mm ² 30, 87 : 1,50 mm ² 87a : 1,00 mm ²
Ambient Temperature	-40 / +80 °C

Notes

All measurements are in millimeters.

For sockets with cables, standard cable length is 20cm. Cable cross section information is given above.

For sockets with different cable lengths and cross sections, please refer to Socket-Product Coding System page.